

Manufacturing of Molded Interconnect Devices from Prototyping to Mass Production with Laser Direct Structuring

Nils Heininger

LPKF Laser & Electronics AG, Garbsen, Germany

Dr. Wolfgang John

I & T 3D Produktionsgesellschaft mbH, Siegendorf, Austria

Hans-Jürgen Boßler

TRW Automotive Safety Systems GmbH, Aschaffenburg, Germany

Zusammenfassung

Spritzgegossene Schaltungsträger (Moulded Interconnect Devices - MIDs) eröffnen die Chance, Elektronik und Mechanik miteinander zu verbinden. Neben der größeren Gestaltungsfreiheit im Vergleich zu konventionellen Schaltungsträgern bietet die MID-Technologie zudem ein enormes Rationalisierungspotenzial durch die Verkürzung der Prozesskette. Zudem tragen 3D-Leiterplatten durch die Reduzierung der Teileanzahl zur Miniaturisierung elektronischer Baugruppen bei.

Wesentliche Einsatzgebiete für die MID-Technologie sind die Automobilelektronik und die Telekommunikation, daneben aber z.B. auch Computer-, Hausgeräte- oder die Medizintechnik.

Mit dem von LPKF entwickelten Laser-Direkt-Strukturierungsverfahren (LDS) ist es möglich, hochauflösende Schaltungslayouts auf komplexen dreidimensionalen Trägerstrukturen zu realisieren und damit die bisher getrennten Einheiten Gehäuse und Leiterplatte funktionell zu integrieren.

Die Grundlage des Verfahrens bilden dotierte Thermoplaste, auf denen die zu realisierenden Leiterbahnen mittels Laser gezielt aktiviert und anschließend im chemischen Bad metallisiert werden können.

Im weiteren werden die technischen, wie wirtschaftlichen Vorteile dieses Verfahrens angesprochen, so wie die Umsetzung von der Produktentwicklung bis zur Serienproduktion anhand einer konkreten Anwendung aus dem Automotive-Bereich vorgestellt.

Abstract

Moulded Interconnect Devices – MIDs present the chance to combine electronic and mechanical parts. Compared to conventional circuits, MID technology offers a greater freedom of design and, due to the shortened process chain, a tremendous potential of rationalization. Moreover, by reducing the number of required parts, three-dimensional circuit carriers contribute to the miniaturization of electronic components.

The main application areas of MID technology are automotive electronics and telecommunications, as well as computer technology, household appliances and medical technology.

With LPKF's Laser Direct Structuring process (LDS) it is possible to produce high-resolution circuit layouts on complex three-dimensional carrier structures, thus integrating casings and PCBs within one unit that previously were separate.

The process is based on doped thermoplastic materials on which the tracks required for the circuit layout are activated by means of targeted laser radiation, and then metallized in a chemical bath.

Further discussed are technical and economical advantages of this process as well as the transfer from product development to series production, using a specific application from the automotive area.

1 Introduction

Continuing miniaturisation and the increasing complexity of moulded parts arising from the integration of functions, not to mention the steady reduction in product lifecycles, are the main challenges faced today by the providers of modern, high-quality function components, particularly in the electronics/electrical industry, but also increasingly in the automotive, medical and telecommunications industry. At the same time, most products also suffer from increasing competitive pressure to deliver continuously improved performance simultaneously with enhanced reliability and lower prices. This particularly applies to the automotive and automotive subcontracting sectors because modern mid-range cars contain an increasingly large amount of electronics and microsystem components. The annual growth in the automotive sector of semiconductor costs alone in recent years was 17 % [1]. It is not only essential to reduce the dimensions, weight and energy consumption, it is also necessary to simplify and shorten the production methods so that production in high-wage countries stays competitive. This means that the number of components and the assembly costs have to be reduced considerably. Moulded interconnect devices (MIDs) combined with suitable installation and connection technologies are ideally suited to achieve these aims. MIDs make use of the very high three-dimensional design flexibility of plastic injection moulding, and integrate mechanical and electrical functions within one module. For instance, typical mechanical functions such as buttons, plugs and other connection elements can be simultaneously integrated within a functional component acting as a circuit carrier. Depending on the application, it is possible to create simple tracks to replace wires, as well as ultra-fine circuits in the form of sensor modules or as chip housings for micro-packaging.

Using the Laser Direct Structuring method (LDS) developed by LPKF, it is possible to create high resolution circuits on complex MIDs, and to functionally integrate the housing and PCB as discussed above. The method is based on doped thermoplastics on which the tracks in the circuits can be precisely activated using laser light and subsequently metallised in a chemical bath.

The basic idea behind this technology is using laser radiation to activate special organo-metal substances in plastic, and to subsequently metallise these activated nuclei in a chemical bath without an electronic current. The laser structuring simultaneously creates the surface structure at the plastic/metal boundary responsible for the high degree of adhesion.

To close the gap between product development and series production, duroplasts with appropriate organo-metal substances can be doped, in addition to a number of high-performance thermoplastics. The duroplasts are used as resin-hardening systems for established prototyping methods such as the vacuum casting of polyurethane resins. This enables developers to create prototypes of injection moulded circuit carriers without having to invest in expensive injection moulding tools. The LPKF-LDS method can be used to very quickly manufacture electrically functional prototypes on the basis of 3-D CAD volume data. This enables the development times to be significantly shortened during the product development process. In addition, it gives users the ability to make important decisions early on for the further product development process. This is often critical for the inter-disciplinary MID technology which teams up electronic engineers and designers, but is unfortunately often difficult to achieve smoothly with conventional MID production

technologies. This inhibitory factor is the reason why many potential users of MID technology consider it too risky to become involved [2].

An example from the automotive sector is used in the following to demonstrate how the LPKF-LDS method can bring an MID application from prototyping to series production within a very short period of time and without any major development risk, at the same time as meeting the higher demands facing today's automotive subcontractors.

2 The LPKF-LDS-Technology

In the past, MID products with real three-dimensional structures have primarily been produced using two-component injection moulding (2-shot-molding) with subsequent chemical surface activation and selective metal coating – a method involving high initial costs and which is only economically viable for large production numbers. The MID production method using laser structuring throws out the 2-shot-molding and enables MID blanks to be produced by single component injection moulding.

And compared to subtractive laser structuring, the additive LPKF-LDS-Technology also benefits from a very short process chain. The main process steps are shown in figure 1.

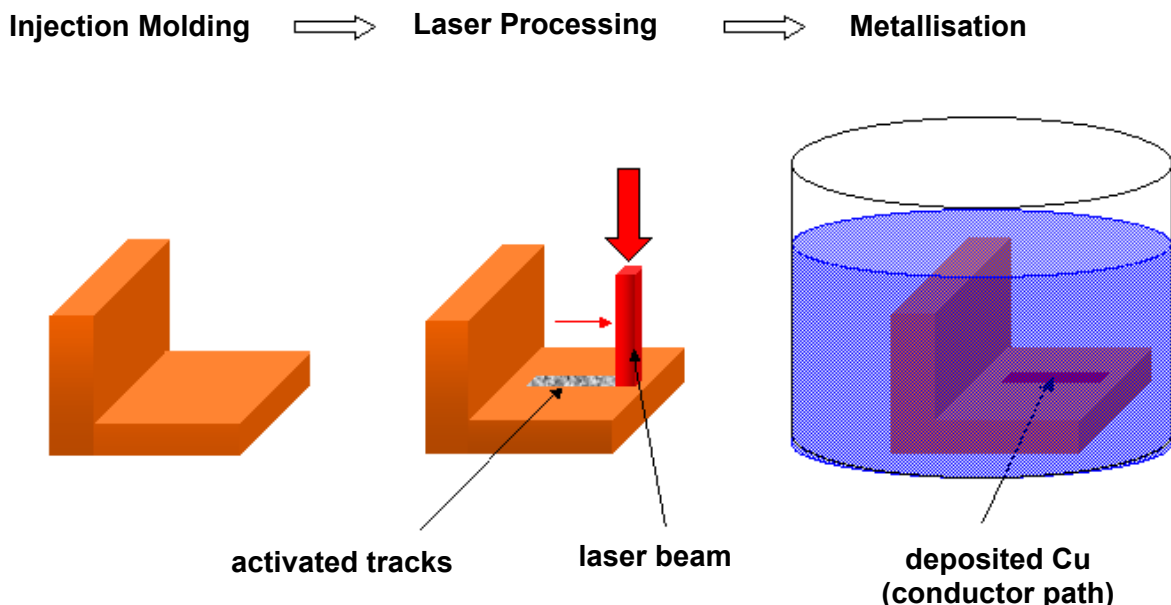

Figure 1: LPKF-LDS-process steps

Compared to conventional methods, laser direct structuring has additional advantages in the production of ultra-fine tracks. Moreover, this method also gives high degrees of flexibility for the conductor layout because modifications can be easily incorporated by changing the structuring data. This enables subsequent changes to be made to the circuit layout without having to modify any tools. This degree of flexibility in particular enables users to harness the benefits of laser direct structuring for their product development processes in the firm knowledge that this can simultaneously provide them with a series production process and therefore

makes the cost and time-intensive transfer of prototype production to series production unnecessary.

The application-oriented selection and industrial availability of the standard laser-activatable plastics used by the electronics industry is an important prerequisite for the use of the LDS method for series production. This availability is guaranteed by the intensive material development and corresponding licence contracts with the relevant plastic-makers: in this context, LPKF has already signed agreements with BASF AG, Bayer Material Science AG (since 01.07.04 LANXESS), Degussa AG and Ticona GmbH.

2.1 Principle behind the method

To circumvent the disadvantages of conventional MID methods [3-8], thermoplastic materials are modified so that an organo-metallic complex is dissolved or finely dispersed within the material. This special chemical compound can be modified by a laser beam in such a way that it catalyses selective metal precipitation in the lasered zones during the subsequent wet metallisation process.

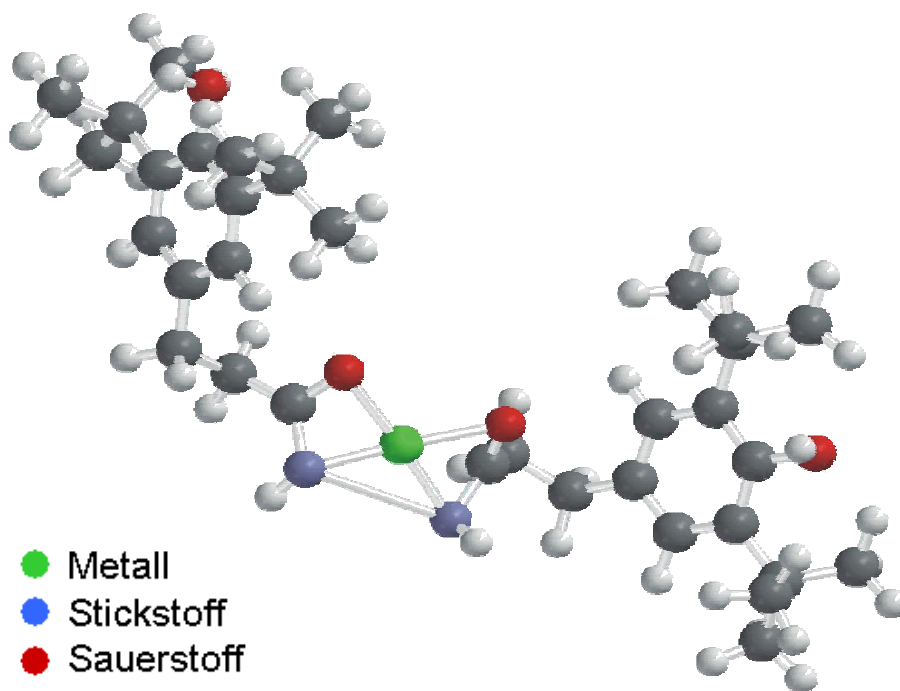

Figure 2: Basic structure of a metal complex

Figure 2 shows the basic structure of a metal complex of this type. A favourable form is a chelate complex of a precious metal – either palladium (Pd^{2+}) or copper (Cu^{2+}) [9]. The organo-metallic complex has to fulfil a wide range of specifications. The thermal stability must comply with the processing temperature of the thermoplastic matrix and it has to be able to split in a defined way into the metal atom and the organic ligand fragments when hit by a high-energy laser beam. Other criteria include:

- good compatibility with the polymer matrix
- no diminution in the electrical properties
- adequate solubility or distribution in the matrix
- no catalytic activity leading to the formation of polymer chains
- extraction-resistant
- non-toxic.

An important parameter for qualifying electronic subassemblies is the adhesive force of the tracks. A high level of initial adhesive strength is specified to guarantee that the tracks properly adhere to the substrate even after undergoing an appropriate number of environmental cycles. The initial adhesive strength in PCB engineering is defined as between 0.6 – 1.1 N/mm in accordance with DIN IEC 326. Another important property of the laser activation also has benefits in this context: it is not only able to selectively and homolytically split the metal complex, the laser beam also ablates the polymer surface. This involves absorption of the laser energy by the polymer molecules which become excited and vibrate. Ideally, the bonds between the molecules would break with the input of a minimum amount of energy. In practice, in addition to pure photochemical ablation, the laser beam causes relaxation and associated thermal vaporisation of the material (figure 3). This sublimation process becomes predominant particularly when long wavelength laser light is used, e.g. an Nd:YAG laser ($\lambda = 1064 \text{ nm}$).



Bild 3: Main laser ablation processes

By modifying a polymer in a suitable way with non-ablatable or only poorly ablatable fillers (mostly inorganic materials), lasering results in microscopically-small cavities and undercuts which in themselves enable good adhesion between the plastic and the precipitating metal layer without the need for complicated extra treatment. The principle mode of action of the laser beam on the surface of the plastic is shown in figure 4.

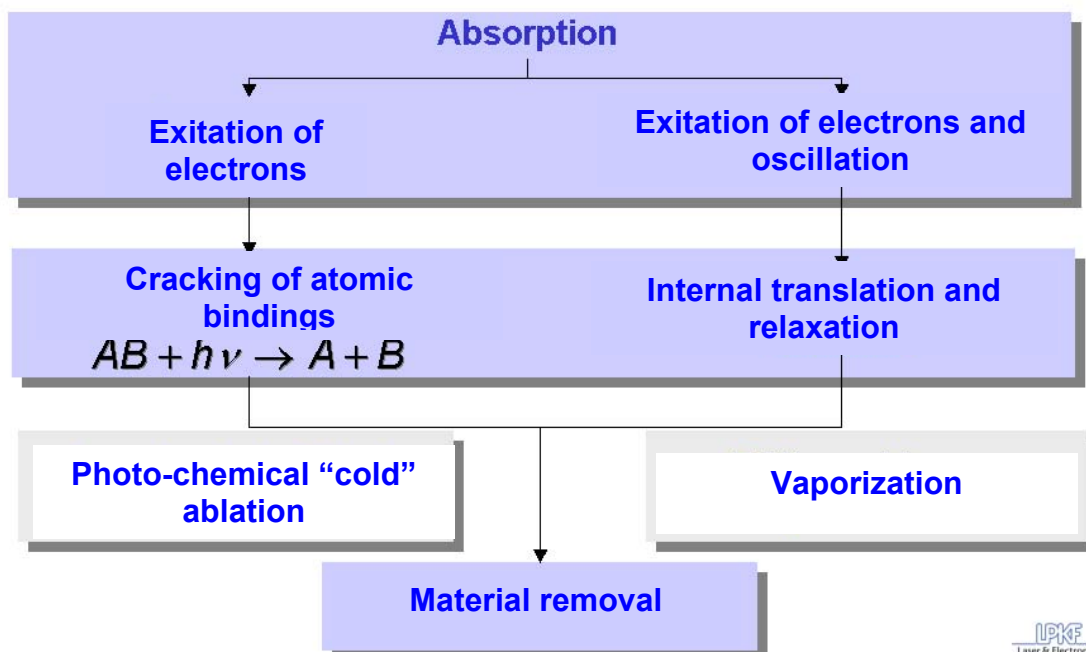
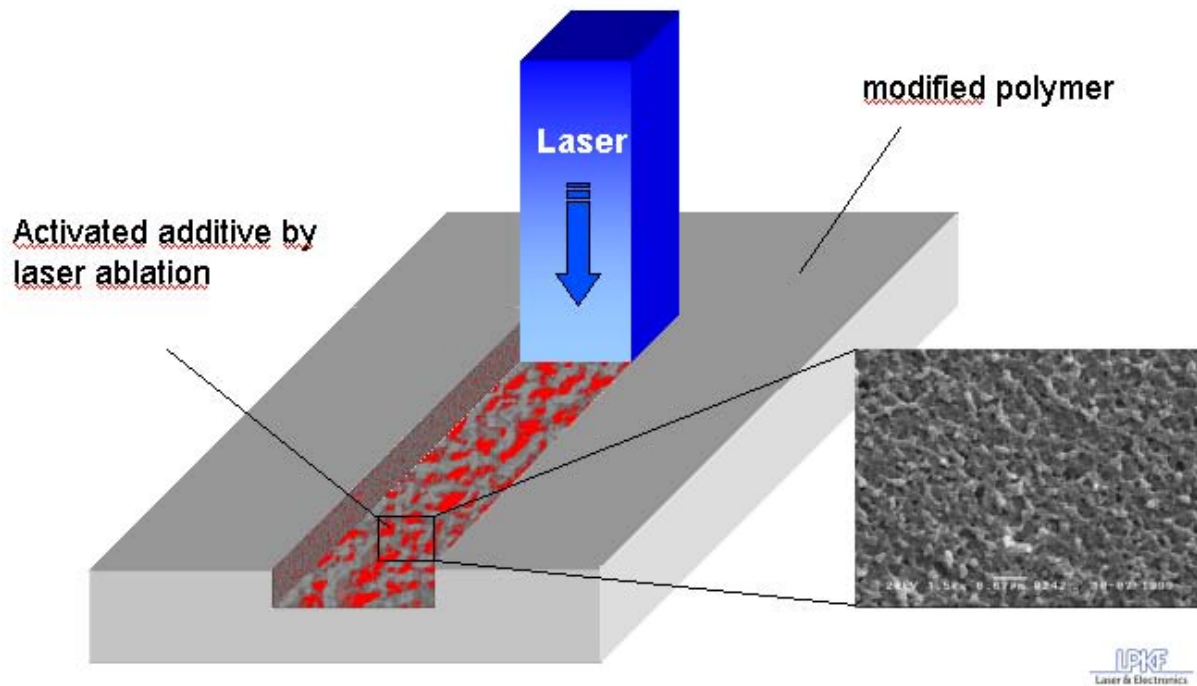

Figure 4: Sketch showing the principles of laser direct structuring (LDS)

2.2 Modular 3D laser system for the LDS method

The MicroLine 3D Industrial is a specially designed laser system for the laser direct structuring of injection-moulded MIDs. One of the main advantages of processing materials with laser light is the feedback-free impact on the material combined with high processing speeds. In addition, the circuit layout can be created by the binary control of an optical processing head and is not predetermined by the geometry of a fixed tool (e.g. stamping dyes, 2-shot-tools). This gives shorter lead times and high levels of flexibility and economic efficiency.

At the heart of each LPKF MicroLine 3D laser system is the above mentioned processing head with three optical axes. Structures smaller than 100 μm can be produced on three-dimensional mouldings thanks to the very rapid control and highly precise optics. The focused beam of a diode-pumped solid-state laser with a wavelength of 1064 nm is reflected with virtually no mass inertia by mirrors onto the surface of the MID. An f-Theta-lens focus the beam onto the processing level, where a linear translator – a telescope with controllable lens – can shift the focal spot in a longitudinal direction by the specific defocusing of the telescope. The synchronous control of the telescope and the mirror-deflection unit guides the laser beam along complex three-dimensional surface topographies with high processing speeds of up to 4000 mm s^{-1} (figure 5).

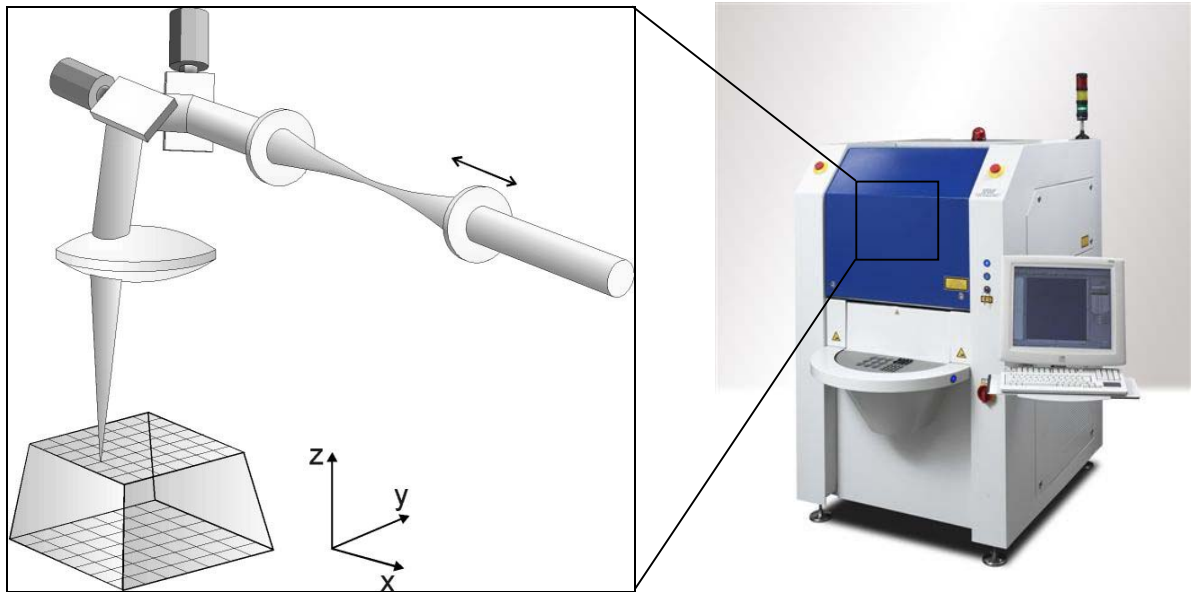

Figure 5: Processing head with three optical axes / LPKF MicroLine 3D Industrial

In addition to the pure structuring time, the feed-in and feed-out of the components being structured determines the cycle time and thus the laser direct structuring throughput. Efficient component handling is therefore an important aspect of process design. Because injection-moulded MIDs have a wide range of shapes and sizes, component handling is generally adapted to suit the geometry of the components being processed. This usually involves a rotary indexing table with a vision system for component location, as well as a version with a tool carrier system configured as a throughput system (figure 6).

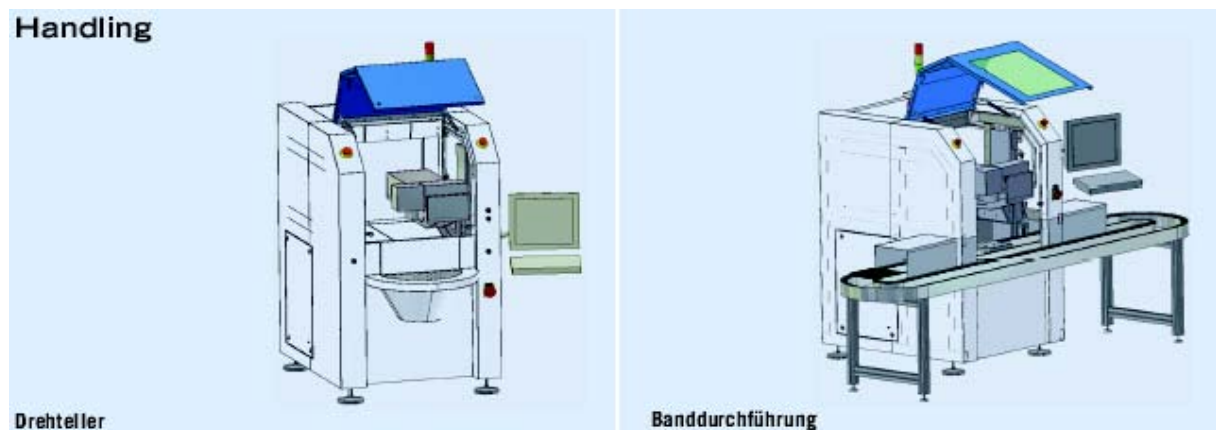

Figure 6: Various handling versions of the LPKF MicroLine 3D Industrial

2.3 Thermoplastic materials for series production

A number of interesting industrial plastics are available which are used by the electronics industry. However, the range of plastics suitable for MIDs is limited. The main criteria they have to fulfil are the ability to be metallised, their adhesive strength, and their temperature resistance during SMD assembly.

The range of thermoplastics is also often restricted further by the MID manufacturing methods: for instance, only thermoplastics with special rheological properties can be used for two-component injection-moulding (e.g. low moulding viscosity to fill in fine cavities).

The aforementioned restrictions do not generally apply to materials for Laser Direct Structuring. Production involves single component injection-moulding and therefore does not demand any special processing properties. The activation and subsequent adhesion of the metal coating is achieved by the surface treatment described in 2.1 (interaction: material – laser). Only the temperature resistance required by many applications limits the range of available materials. However, if soldering is not required and if no high thermoforming resistance is needed, then every type of thermoplastic can in principle be modified for Laser Direct Structuring. The available materials with the appropriate qualifications are listed in table 1.

Property	Unit	Vestodur CL2230	Vestodur CL3230	Ultradur®T 4380 LS	Vectra® E820i LDS	Pocan DP7102	Pocan TP710-003	Pocan TP710-004
Manufacturer	-	Degussa	Degussa	BASF	Ticona	Lanxess	Lanxess	Lanxess
Polymertype	-	PBT	PBT	PA6/6T	LCP	PBT	PBT	PET/PBT
Mold shrinkage	%	parallel 0,2	parallel 1,3	constrained 0,5	parallel/normal 0,3 / 0,4	parallel/normal 1,3/1,3	parallel/normal 1,4 / 1,4	parallel/normal 0,24 / 0,98
Post-shrinkage	%	parallel 0,1	parallel 0,4	-	-	parallel/normal 0,1 / 0,3	parallel/normal 0,3 / 0,3	parallel/normal 0,05 / 0,22
Tensile strength	Mpa	95	44	140	116	55	51	110
Tensile modulus	Mpa	10500	4800	9700	9000	5600	5500	120000
Strain at break	%	1,2	1,1	2,2	4	2	3,3	1,5
Charpy impact strength	kJ/m ²	30 C	15 C	33	19	25	40	25
Density	g/cm ³	1,77	1,67	1,4	1,79	1,57	-	1,75
Melt volume-flow rate (MVR)	cm ³ /10min	28	37	-	-	10	5	16 *
Melting temp. DSC	°C	-	-	295	335	225	225	-
Deflection temp. (HDT/A) 1,8MPa	°C	-	-	-	220	115	110	250 * ²
Content of material/filler	%	30	30	30	40	25	25	40

* = 280°C/2,16 kg *² = 0,45MPa

Table 1: Comparison of material properties

2.3 LDS prototyping

The LPKF-LDS method enables an MID production technique to be used very flexibly within a product development process with the certain knowledge of being able to use the same method for series production – which dispenses with expensive conversion work when moving from prototype to series production. Other advantages of prototypes in product development processes are:

- keeping ahead of the market by cutting development times
- making development samples available within a few days
- major development cost savings
- early testing of specific functions of MIDs undergoing development
- early identification of modifications to shape and circuit layout

The vacuum casting of polyurethane resins (PUR) has proven to be particularly suitable. This is done on the basis of a stereo-lithographically produced original model used to create a silicon mould in which up to 25 polyurethane prototypes can subsequently be made by vacuum casting.

Just as in the case of series production materials (thermoplastics), doping is required with one of the metal complexes described in 2.1. Because polyurethane is a duroplastic resin-hardening system, only one component – preferentially the resin – is modified. The resulting vacuum-cast prototypes can then be laser-activated – in precisely the same way as thermoplastic components during series production – to allow subsequent selective metal precipitation on the lasered areas in the subsequent metallisation process.

PUR vakuu casting resin			
Property	Unit		Test Type ISO
Flexural Strength	N/mm ²	108	178
Flexural Modulus	N/mm ²	2460	178
Tensile Strength	N/mm ²	64	R 527
Izod Impact	Kj/m ²	5	180
Elongation at Break	%	17	R527
Heat Deflection Temperature	C°	95	75

Table 2: Properties of PUR vacuum casting resin

2.4 Metallisation of laser-activated components

The laser-assisted breakdown of metal complexes described in 2.1 creates nuclei which catalyse metal precipitation in the laser-activated zones. This process usually involves the use of chemical copper electrolytes which typically produce copper thicknesses of 5 ... 8 µm. The appropriate surface finish can then be applied. Table 3 shows a typical metallisation step corresponding to a standard industrial process. Note the shorter process chain compared to standard plastic metallisation. There is also no need for environmentally-problematic etching and nucleation steps as required for all-over plastic metallisation or two-component injection-moulding.

Process Step	Bath-Type	t / min	T / °C
Ultrasonic Cleaning	Enplate MID Select 9005	-	70
Chem. Cu 1	Enplate MID select 9070	30 - 45	44 - 45
Chem. Cu 2	Enplate Cu 872	60	47
Aktivation (Pd)	Enplate MID Select 9044	5	25
Chem. Ni	Enplate MID select 9065	30	60
Flash-Au	Enthone Immersion Gold I	15	70
Drying	Dry Storage	60	100

Table 3: Metallisation process sequence

Metallisation is typically carried out on a rack or using the barrel plating method. Integrating LDS metallization processes into installation technology suited for series production requires extensive know how in order to comply with given process windows and a technologically well solved online analysis of the parameters of the metallization bath. Figure 7 shows a 500 l rack plating line apparatus from I&T with integrated online bath monitoring for the control of the complete metallization process sequence.



Figure 7: Fully automated plating line with online-analysis (I&T GmbH)

3 MID application in the automotive sector as used by TRW

As the use of electronics and their functional integration within vehicles increases, additional pressure is also exerted on the costs for electric and micro-system components. As an automotive subcontractor, TRW faces unrelenting competitive pressure to constantly improve performance at the same time as strengthening reliability and lowering prices. To meet this challenge, TRW has elaborated a concept for a multi-function steering wheel in which MID plays a crucial role. The “Base-Line” concept is to be realised in large numbers and be used in middle and lower mid-range cars in particular, because of its relatively low manufacturing costs. The basic idea is to reduce the number of separate components to a minimum and to integrate the whole functionality within one subassembly. The example of a multi-function steering wheel subassembly looked at here highlights this objective very clearly because the previous design not only involved a large number of separate components in the assembly process, but also required wiring between the left-hand and right-hand side of the steering wheel controls. Already from the beginning, special attention was paid to the selection of a suitable partner in possession of the industrial engineering technology suited for series production and experience as supplier in the automotive industry to ensure series production. Austrian company Innovation & Technology is meeting this challenge.

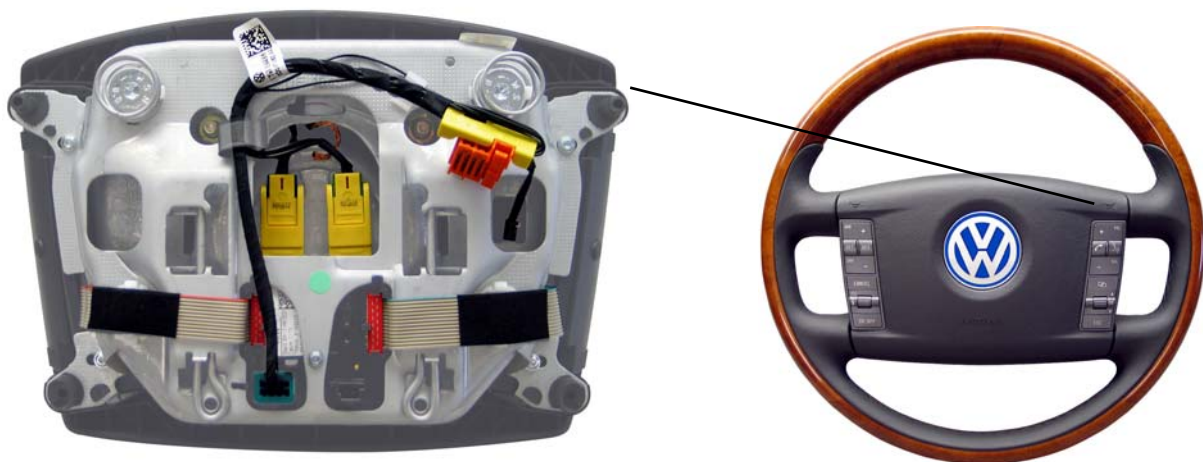

Figure 8: Wiring of a conventional multi-function steering wheel (VW Phaeton)

Elaboration of the MID concept took into consideration from the start the general customer requirements, e.g. design (functionality, quality feel), the haptics (switch feel, switch surfaces) and the quality and environmental requirements (temperature requirements, service life) as well as compliance with all legislation (risk of injury from loose parts, degree of gloss, minimum radius according to ECE R12), not to mention the stability of the components under extreme loads, e.g. attaching a steering wheel lock, extreme use of the horn button under stress, and release of the airbag.

To meet the specification for the lowest possible number of single components, the Base-Line concept incorporates an MID to accommodate the wiring previously involving cables, the electric switching, and the associated SMD subassemblies.

The switching functions of the operating buttons are met with a silicon switching mat. The pad structure required is directly integrated on the underlying MID, as is the connector for the data bus which is first connected to a control unit, which in turn is

connected to the CAR CAN bus. Figure 9 shows an MID solution of this type for a multi-function steering wheel with four switching functions.

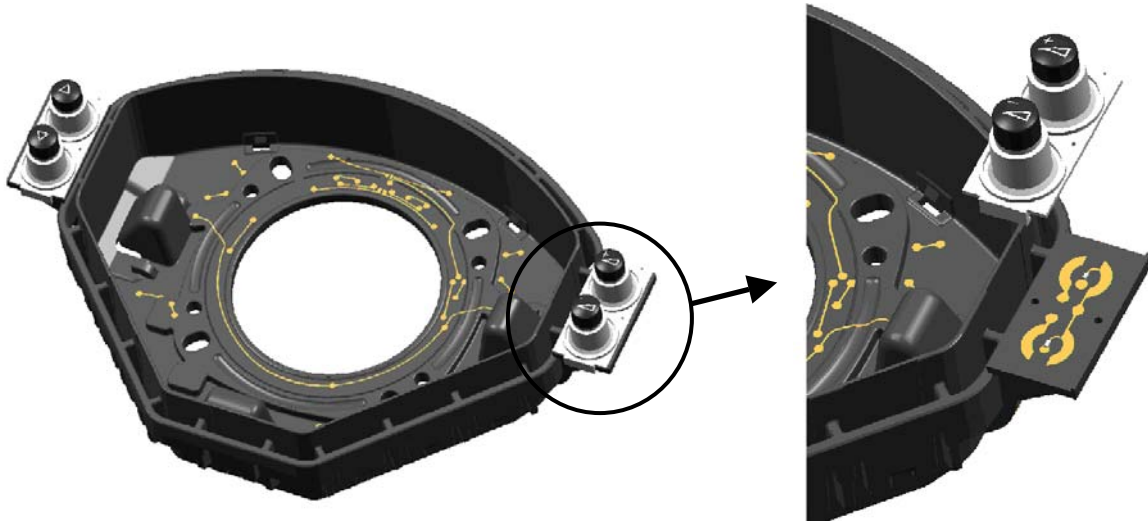

Figure 9: Base-Line concept

3.1 Process-oriented MID design

The LPKF-LDS method makes structuring possible along any surface topography as long as nothing blocks the laser beam, and the surfaces can be reached in projection. Within only a few seconds, the laser beam structures the circuit layout directly from the computer onto the surface of the MID blank. In doing so, the laser carries out two tasks described in 2.1: it activates the doped LDS plastic in the areas defined by the laser as the conductor layout, and it creates a micro-rough surface which guarantees adequate adhesion for the tracks. The three-dimensional laser structuring using the LPKF-LDS method requires focusing to take place precisely along the surface topography of the component, and that the plastic component has been designed in tune with the method and the circuit to be structured.

3.1.1 Layout design rules

The layout of the tracks must lie within the maximum working area of 200 mm x 200 mm at the XY level and a maximum focus height of 25 mm in the Z direction.

In principle, the LPKF-LDS method can be used to create ultra-fine structures with a width of up to 150 μm . However, in the application described here, only 300 μm tracks are required with a pitch of approx. 500 μm in the finest zones. This is possible because of the generous size of the component and the relatively low wiring density. Moreover, a minimum current carrying capacity is required which can only be achieved with wide tracks because the thickness of the copper layers is typically in the 5 ... 8 μm range. Although it is also possible to create copper layers with thicknesses > 8 μm , this can only be done electrolytically, i.e. under the influence of an electric current. This in turn demands that the conductor layout is continuous, and that an interim wiring path is planned into the layout which then needs to be removed again after metallisation.

3.1.2 Component design rules

Because one can expect an additional price for the thermoplastics currently available for the LPKF-LDS method in comparison to the undoped standard materials, an economic factor is minimisation of the injection weight. The MID component in the application described here was therefore only made in the form of a frame capable of being clipped in later to the actual housing.

The cycle time of each component also has to be minimised to ensure similar cost efficiency of the laser structuring side of the LPKF-LDS method. This is mainly determined by the handling time and the structuring time, which is also proportional to the layout area. The handling time is mainly determined by the number of positions into which the component has to be placed. The number of positions and the layout area should be reduced to a minimum by appropriate component design.

Oblique surfaces and flanks with a maximum angle of 75° can be structured using the LPKF-LDS method (figure 10). Larger flank angles are possible but it is essential to guarantee that all of the surfaces can be reached in projection (complying with the max. possible flank angle). Otherwise, the component will have to be laser-structured in several positions with a negative effect on cycle time and productivity.

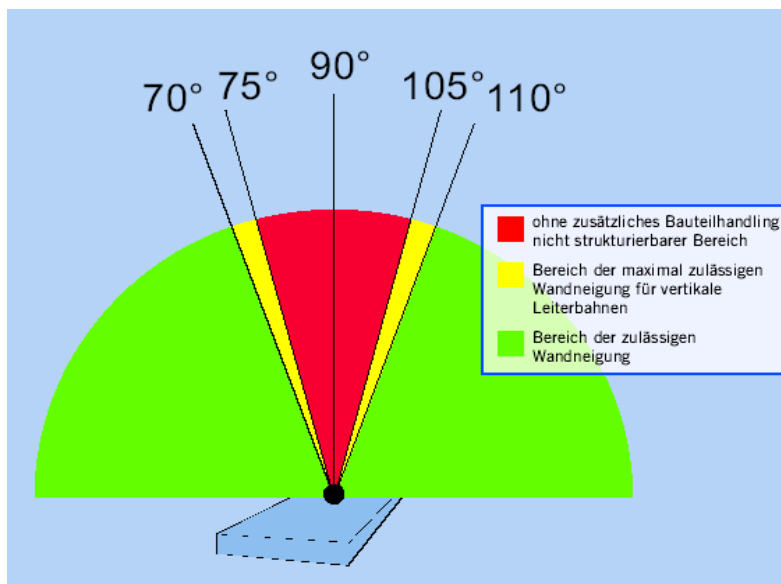

Figure 10: Maximum flank angles for laser direct structuring (LDS)

3.1.3 Positioning marks / fiducials

The LPKF MicroLine 3D Industrial combined with the integrated vision system enables automatic correction of the structuring data relative to the component being structured. The vision system recognises the position of the plastic component via freely definable fiducials (positioning marks), carries out a subsequent online data correction, and turns, moves or scales the structuring data accordingly. The maximum size of the fiducials is 7 mm x 6 mm. In the application described here, these are ideally in the form of circular holes.

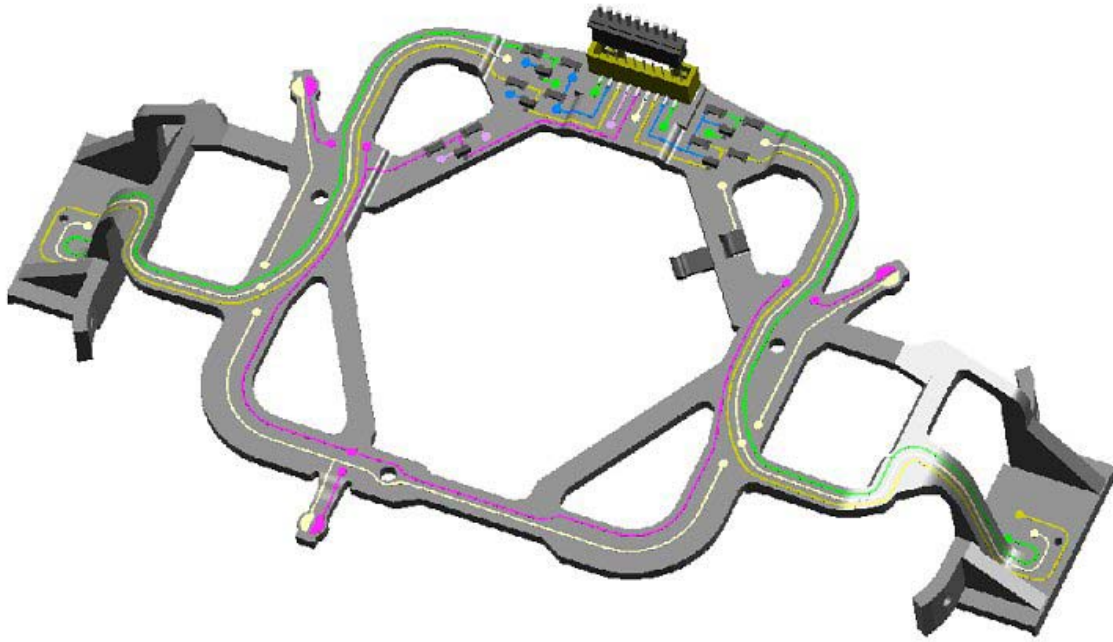

Figure 11: 3D-CAD design model of the MID frame making allowance for the aforementioned design guidelines

3.2 Build up of the MID prototypes

As described in 2.4, the LPKF-LDS method can be used to produce the first near-series production samples by using well established rapid prototyping technologies such as vacuum casting. MID prototypes are required for function and installation tests, firming up the whole process chain, determining the production costs, and last but not least, as a basis for negotiating OEM details.

When the process-oriented design stage has been concluded as described in 3.1, the 3D-CAD data generated from this design are used to produce a master model. This usually involves a stereo-lithographic method (SL) to build up the component layer by layer by hardening a UV-sensitive varnish layer by layer. The thickness of each layer is determined by the geometrical accuracy or resolution of the SL component. This master model is subsequently used to generate a silicon mould which is in turn used to produce several prototypes. This last step is preceded by applying a finish by e.g. painting to smooth out the above mentioned stepped edges of each layer.

To produce a silicone mould, the finished master model is suspended in a casting rack and selecting the stalks, risers and the parting planes of both halves of the tool. The casting rack is then filled with silicone. After hardening, the mould is cut open along a wavy line following the parting plane, and the master model is removed. The silicone tool produced in this way is suitable for up to 25 casts of specially doped polyurethane using the vacuum casting method.

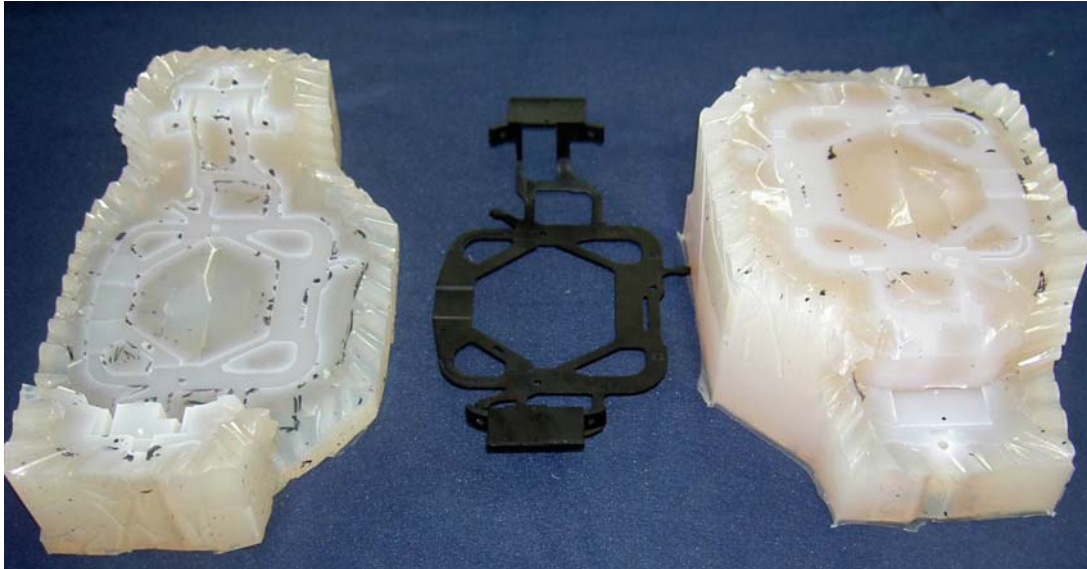

Figure 12: Vacuum casting mould with cast of doped polyurethane (KLM GmbH)

The polyurethane prototypes produced in this way are then laser-structured and metallised using the LDS method in exactly the same way as they would during series production (cf. 2). Because polyurethane only has limited thermoforming resistance, the sample components are assembled manually using a hand-held soldering iron.

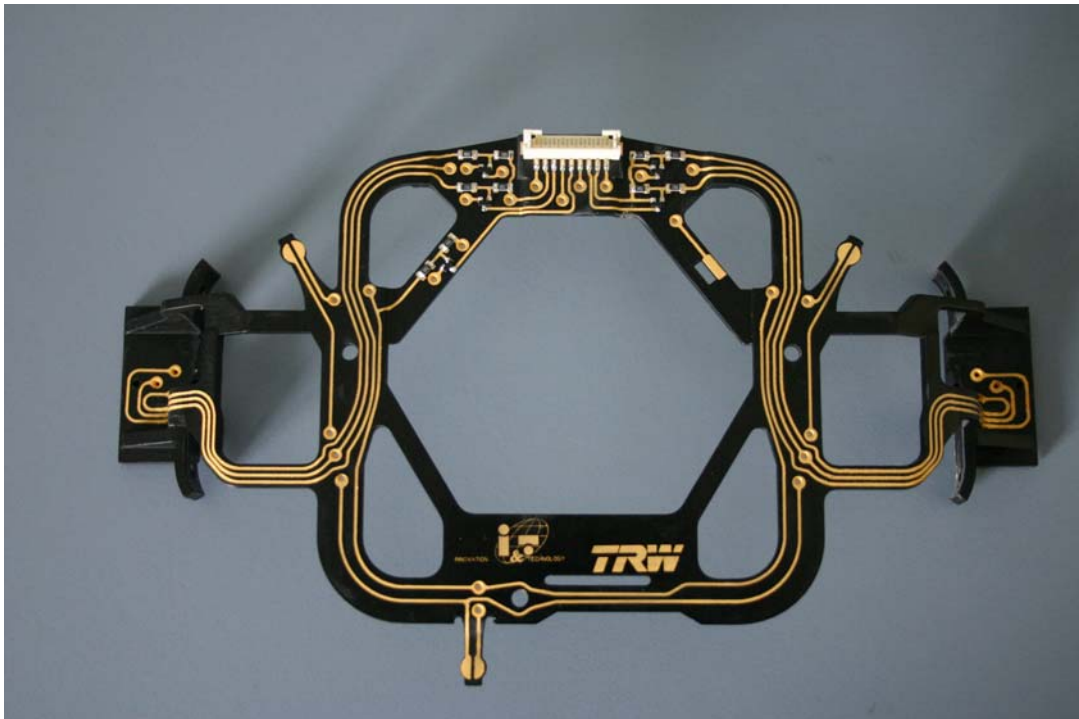

Figure 13: Assembled Base-Line MID prototype made of polyurethane

3.3 Material selection

Approx. 11 resistors and 5 transistors and an SMD-compatible connector housing are assembled on the MID (cf. figure 13). Lead-free reflow soldering was selected in

accordance with the stress and reliability specifications. Figure 14 shows a typical temperature profile for an SnAg(Cu) solder also specially selected for this application.

Because of the minimum thermoforming resistance based on the reflow profile, as well as the three specifications discussed in section 3 for the Base-Line concept, a semi-aromatic polyamide (PA6/6T) from BASF, and a PET/PBT blend from Bayer/Lanxess were selected as potential series materials (cf. table 1).

The first soldering tests on suitable samples were carried out in parallel to the prototype phase and before starting tool design to enable an informed choice to be made between the two materials and to design the series tools accordingly.

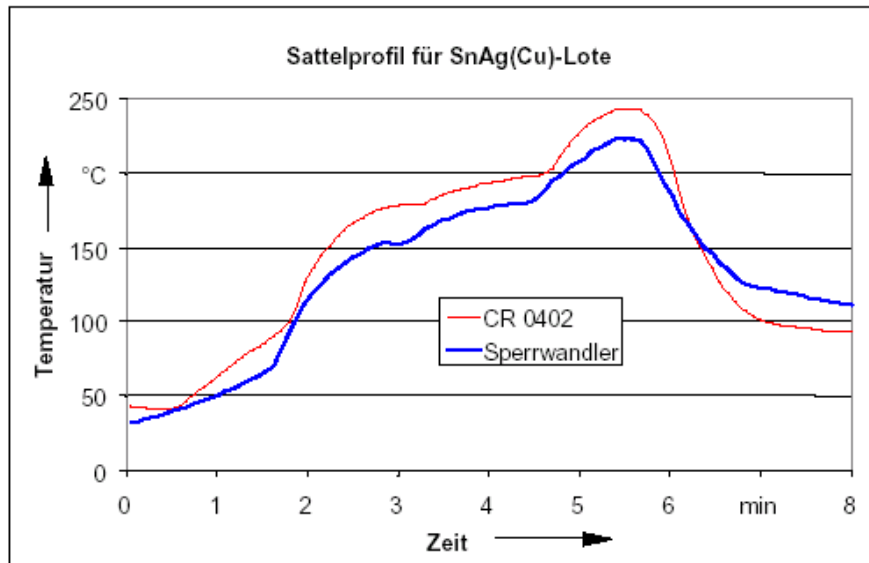

Figure 14: Reflow profile of lead-free SnAg(Cu) solder (FAPS, University of Erlangen)

A number of environmental tests were subsequently carried out on the successfully soldered test boards which although not capable of replacing the qualification of the series components required at a later stage, do provide a valuable indication of the approximate behaviour of the subsequent component.

4 Summary of the results

4.1 Qualification results

The following specifications for the MID concept which need to be tested are derived from the quality demands discussed in section 3. These are aimed at guaranteeing the function of a subassembly throughout the whole service life under all possible stress conditions:

- temperature range – 35 °C to + 85 °C
- temperature shock in accordance with VW TL 80101
- function stress throughout temperature range in accordance with VW TL 80101
- vibration according to VW TL 80101

The test boards described in 3.2 have so far been used to successfully test the initial adhesion strength of the tracks. The subsequent climatic test and the mechanical stress tests have so far produced successful results. The shear strength of the soldered SMD components was also tested (cf. figures 15 to 17).

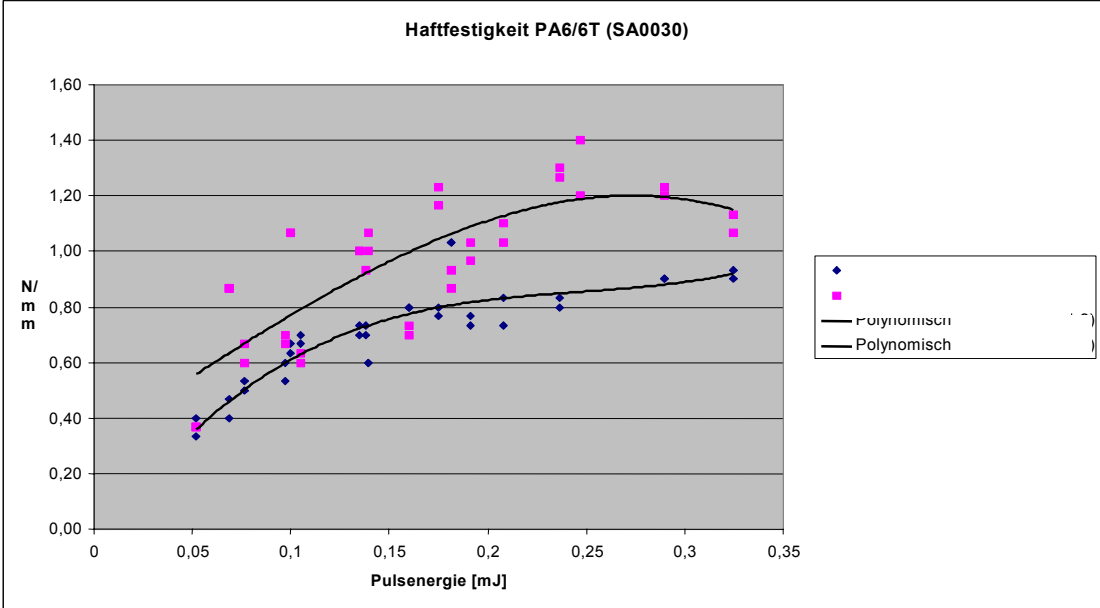

Figure 15: Peel strength on PA6/6T depending on fluence (Mechatronik project)

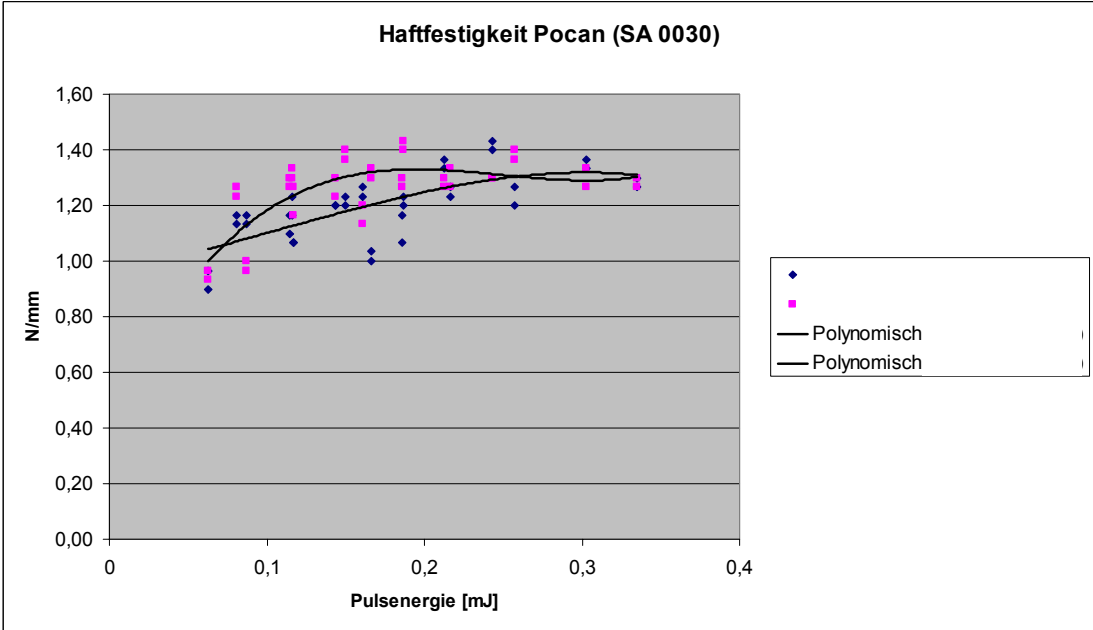

Figure 16: Peel strength on PBT depending on fluence (Mechatronik project)

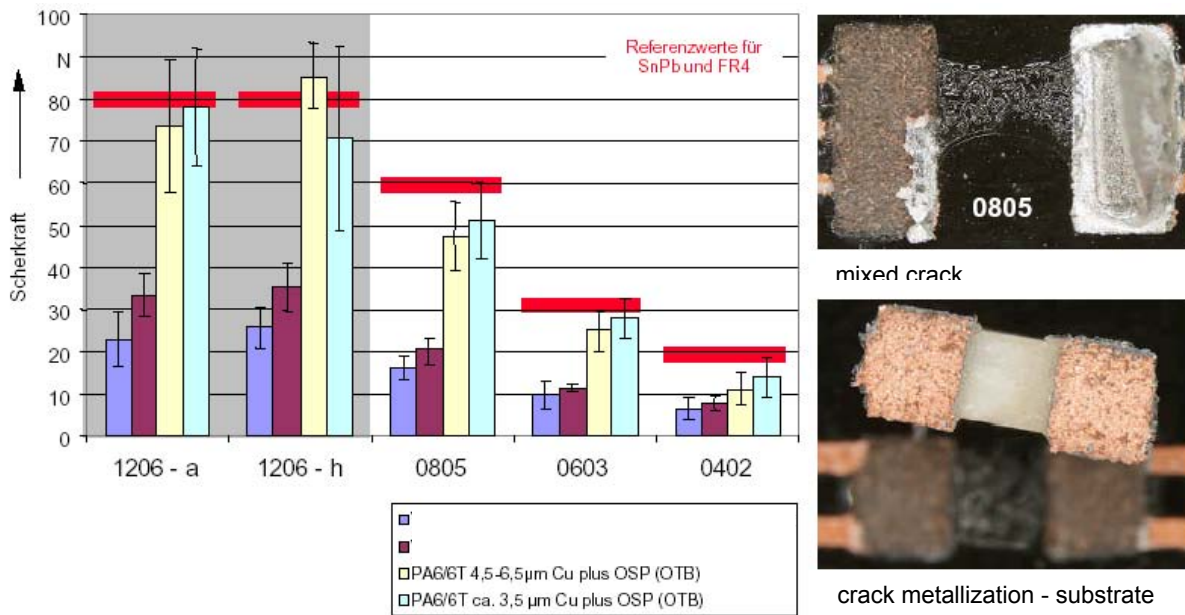

Figure 17: Evaluation of shear strength on PA6/6T (Mechatronik project)

6.2 Concept evaluation result

The use of MIDs produced using the LPKF-LDS method, as high-quality functional components which integrate mechanical and electrical functions, gives rise to a number of design and cost benefits:

- component reduction (tool costs)
- assembly, logistics, testing and development cost savings
- signal wiring at several levels – new possibilities
- construction space optimisation
- no cable laying required (no tangle of cables)
- higher functional reliability through fewer interfaces
- flexibility – different circuit types possible
- simpler component design (DSB switch)
- use of existing electrical contact systems

In addition to the above mentioned general advantages, the MID prototypes described in section 3.3 also make it possible at a very early stage to fairly accurately assess the costs for producing the subsequent series components. On the basis of the current estimates, cost savings of approx. 20 % are possible using the Base-Line concept compared to conventional solutions.

5 Outlook

The LPKF-LDS method is a technology for the efficient and flexible production of 3D-MIDs. Unlike other production methods, Laser Direct Structuring enables thermoplastic MIDs to be manufactured in only three processing steps (injection-moulding, laser structuring, metallisation) without any layout-specific tools such as injection-moulding or stamping dies. The associated flexibility can be ideally used for product development processes, as graphically demonstrated by the TRW Base-Line concept.

As a system supplier in the automotive sector, TRW is responsible for the whole “steering wheel” subassembly including the necessary electronic modules (control device, data bus, flat spiral spring). The MIDs, which are the heart of TRW’s new innovative concept as high-quality function components, will be supplied by I&T.

High-quality MIDs as functional components are the core of the new innovative concept, and they are provided for series production by company I&T from Austria as partner company for development and production.

Besides its core business, which is the development and production of automotive wiring systems based on flat conductors, company I&T has many years experience in the area of structuring and metallization of MID component groups and very soon they will be able to present the complete LDS process chain by using the appropriate laser system technology of company LPKF. A special challenge is faced as far as the step-by-step „upscaling“ of the metallization processes from the lab to the industrial large series production is concerned, taking into consideration the criteria for quality and stability for technological processes in the automotive industry. With its highly developed installation engineering company I&T provides the best conditions.

Using prototypes, TRW in the mean time introduced the Base-Line-Concept to a number of OEMs, thus aiming at starting a real series production project during this year. A number of further MID prototypes with specific customer layout from OEMs are currently being designed.

7 References

- [1] „Aufbau und Verbindungstechnik für Mechatronik-Anwendungen im Automobil“
- [2] „Chancen und Grenzen für den Einsatz der Technologie MID“, Studie des Heinz Nixdorf Institut, Universität Paderborn, Rechnerintegrierte Produktion, Prof. Dr.-Ing. Jürgen Gausemeier, Paderborn, 2003
- [3] Scheel, W. (Hrsg.): Baugruppentechologie der Elektronik, 2. erweiterte Ausg., Verlag Leuze, Saulgau, 1999
- [4] Kunststoff-Metallisierung – Handbuch für Theorie und Praxis, Saulgau, 1991
- [5] Ebneith, H.: Metallisieren von Kunststoffen, expert-Verlag, Renningen-Malmsheim, 1995
- [6] Steffen, H.: Kupfer in der Leiterplattentechnik. In: Kanani, N. (Hrsg.): Kupferschichten, 1. Aufl., Leuze Verlag, Saulgau, 2000
- [7] Jehn, H. A.: Galvanische Schichten, expert-Verlag, Ehningen, 1993
- [8] Forschungsvereinigung Räumlich Elektronischer Baugruppen 3-D MID e.V. (Hrsg.): „Herstellungsverfahren, Gebrauchsanforderungen und Materialkennwerte Räumlicher Elektronischer Baugruppen 3-D MID“, Handbuch für Anwender und Hersteller, 1. gebundene Ausg., Erlangen, 2004
- [9] „Laserunterstützte, volladditive Metallisierung hochtemperaturbeständiger Kunststoffe für 3D-MIDs“, R. Schlüter, J. Kickelhain, M. Hüske, Ulmer Gespräche, 05/2002